



MINI MERLIN

CH₄ CO: DUAL GAS DETECTOR

Methane (Natural Gas) & Carbon Monoxide



Installation & Operation Manual

Please read this manual carefully and retain for future use.

Your new Mini Merlin is a dual gas sensor carefully designed and tested to monitor levels of Methane (CH₄) / Natural Gas and Carbon Monoxide (CO) in the air. If there is a dangerous build-up of gas or unsafe levels of carbon monoxide at the sensor, this device can shut off the gas supply via a gas safety valve and /or a gas fired appliance. This device has additional features for resetting systems, as well as audible and visual alarms - It can also be integrated with a Building Management System (BMS).

The information contained within this manual should be referenced for typical installation and operation only. For specific requirements that may deviate from the information in this guide – contact your supplier.

CONTENT

IMPORTANT SAFETY INSTRUCTIONS	3
Manufacturer's Warranty	3
CARBON MONOXIDE GAS	4
General Information	4
METHANE GAS	5
General Information	5
INSTALLATION	6
Planning.....	6
Typical Location and Positioning.....	6
Mounting.....	7
Circuit Board Overview	8
Wiring	8
Auto Reset & Buzzer Switches	10
Building Management System Integration.....	10
Specification	10
OPERATION	11
First Power Up	11
Touch Button	11
Device Overview	11
Gas Level Alarms	12
Remote Shut Off Screen.....	12
End of Life Screen.....	12
General Maintenance	13
Bump Testing	14
INSTALLATION DETAILS	16



IMPORTANT SAFETY INSTRUCTIONS

- Before any installation, use or maintenance read this manual carefully.
- The information contained within this manual should be referenced for typical installation and operation only.
- For site specific requirements that may deviate from the information in this guide – contact your supplier.
- If this device is used in a manner not specified by the manufacturer, the safety and / or protection provided by this device may be impaired.
- This device is designed for indoor operation only.
- The internal fuse should be replaced only with the same type. Anti-surge fuse 3.15A 250Vac 5x20.
- The expected lifetime of gas sensor elements is 5 years upon initial power up. The device will display a message to indicate this time and should immediately be replaced.
- It is recommended that this device be commissioned upon installation and serviced annually.
- Do not apply lighter gas or other aerosols to the device – this will cause extreme damage.
- High concentrations of alcohol / ethanol found in many products may damage, deteriorate or affect the gas sensing elements – Avoid exposure near your device.
- This equipment is designed to detect carbon monoxide and natural gas from any source of combustion.
- It is NOT designed to detect smoke, fire or other gases and should NOT be used as such.
- This device provides early warning of the presence of methane or carbon monoxide, usually before a healthy adult would experience symptoms. This early warning is possible provided your alarm is located, installed and maintained as described in this guide.
- This device requires a continual supply of electrical power – it will not work without power.
- This device should not be used to substitute proper installation, use and / or maintenance of fuel burning appliances including appropriate ventilation and exhaust systems.
- This device does not prevent methane or carbon monoxide from occurring or accumulating.
- Actuation of your alarm indicates the presence of dangerous levels of Methane or CO.
- Seek fresh air supply and contact your local gas emergency service should you suspect a gas leak.
- This device may not fully safeguard individuals with specific medical conditions.
- If in doubt, consult a doctor / physician.
- Your product should reach you in perfect condition, if you suspect it is damaged, contact your supplier.

Manufacturer's Warranty

Warranty Coverage: The manufacturer warrants to the original consumer purchaser, that this product will be free of defects in material and workmanship for a period of three (3) years from date of purchase.

The manufacturer's liability hereunder is limited to replacement of the product with repaired product at the discretion of the manufacturer. This warranty is void if the product has been damaged by accident, unreasonable use, neglect, tampering or other causes not arising from defects in material or workmanship.

This warranty extends to the original consumer purchaser of the product only.

Disclaimers: Any implied warranties arising out of this sale, including but not limited to the implied warranties of description, merchantability and intended operational purpose, are limited in duration to the above warranty period. In no event shall the manufacturer be liable for loss of use of this product or for any indirect, special, incidental or consequential damages, or costs, or expenses incurred by the consumer or any other user of this product, whether due to a breach of contract, negligence, strict liability in tort or otherwise. The manufacturer shall have no liability for any personal injury, property damage or any special, incidental, contingent or consequential damage of any kind resulting from gas leakage, fire or explosion. This warranty does not affect your statutory rights.

Performance: During the above warranty period, your product will be replaced with a comparable product if the defective product is returned together with proof of purchase date. The replacement product will be in warranty for the remainder of the original warranty period or for six months – whichever is the greatest.



Information on waste disposal for consumers of electrical & electronic equipment.

When this product has reached the end of its life it must be treated as Waste Electrical & Electronics Equipment (WEEE).

Any WEEE marked products must not be mixed with general household waste, but kept separate for the treatment, recovery and recycling of the materials used. Please contact your supplier or local authority for details of recycling schemes in your area.

CARBON MONOXIDE GAS

General Information

Carbon monoxide (CO) is a poisonous, colourless, odourless, and tasteless gas. Although it has no detectable odour, CO is often mixed with other gases that do have an odour. So, you can inhale carbon monoxide right along with gases that you can smell and not be aware that CO is present.

SYMPTOMS OF CARBON MONOXIDE GAS POISONING

The following symptoms are related to CO poisoning and should be discussed with all members of the household, facility or person(s) frequenting monitored areas.

Mild Exposure: Slight headache, nausea, vomiting, fatigue, flu-like symptoms.

Medium Exposure: Severe headache, drowsiness, confusion, increased heart rate.

Extreme Exposure: Unconsciousness, convulsions, cardio-respiratory failure, death.

If you experience even mild symptoms of exposure – consult a doctor / physician immediately.

CARBON MONOXIDE GAS LEVELS

This device is equipped with a digital display that shows levels of CO displayed in PPM (parts per million).

Dangerous levels: Generally above 100ppm. This should be treated as an urgent situation.

Medium levels: Generally between 50ppm to 100ppm. This should be cause for concern and should not be ignored or dismissed.

Low levels: Maximum acceptable indoor level of CO is <9ppm. Anything above this level may cause possible health effects with long-term exposure.

See the specification table for how your device monitors Carbon Monoxide gas.

POSSIBLE SOURCES OF CARBON MONOXIDE GAS

Inside your home or facility, gas appliances used for heating, water heating and cooking are the most likely sources of CO. Vehicles running in attached garages can also produce dangerous levels of CO.

CO can be produced when burning any fossil fuel, such as gasoline, propane, natural gas, oil and wood. It can be produced in any fuel burning appliance that is malfunctioning, improperly installed or insufficiently ventilated.

- Automobiles, gas stoves, water heaters, portable fuel burning heaters, fireplaces.
- Blocked chimneys or flues, corroded or disconnected vent pipes.
- Vehicles and other combustion engines running in open or confined spaces.
- Burning charcoal or fuel in grills in an enclosed area or near the home.

For more information, please visit our website or contact your local AGS distributor.

METHANE GAS

General Information

Methane gas comes from the earth and it comes from our bodies. Methane is non-toxic and it can be harnessed as an energy source. However, methane is highly explosive and it can cause death by asphyxiation. It is important to understand how to deal with the hazards associated with methane.

Although methane on its own isn't poisonous, it has the potential to become poisonous when mixed with other substances. That potential exists when natural gas (CH₄), which is 97% methane, is burned in houses, offices and businesses. The burning of natural gas without proper ventilation can produce carbon monoxide, a deadly gas that is difficult to detect.

SYMPTOMS OF METHANE GAS EXPOSURE

Methane gas is relatively non-toxic and associated with being a simple asphyxiator displacing oxygen in the lungs. However Methane is extremely combustible.

Exposure to high levels of Methane can cause:

- Suffocation
- Loss of consciousness
- Headache and dizziness
- Nausea and vomiting
- Weakness
- Loss of co-ordination
- Increased breathing rate

METHANE GAS LEVELS - %

The LEL (Lower Explosive Limit) of methane is considered to be 5% BV (by volume of air). So we call 5% BV (by volume) the same as 100% of the LEL (Lower Explosion Limit).

Your device is equipped with a digital display that shows the level of natural gas in the area referred to as LEL% (a percentage of the LEL) and will alarm based on the following principle of gas detection.

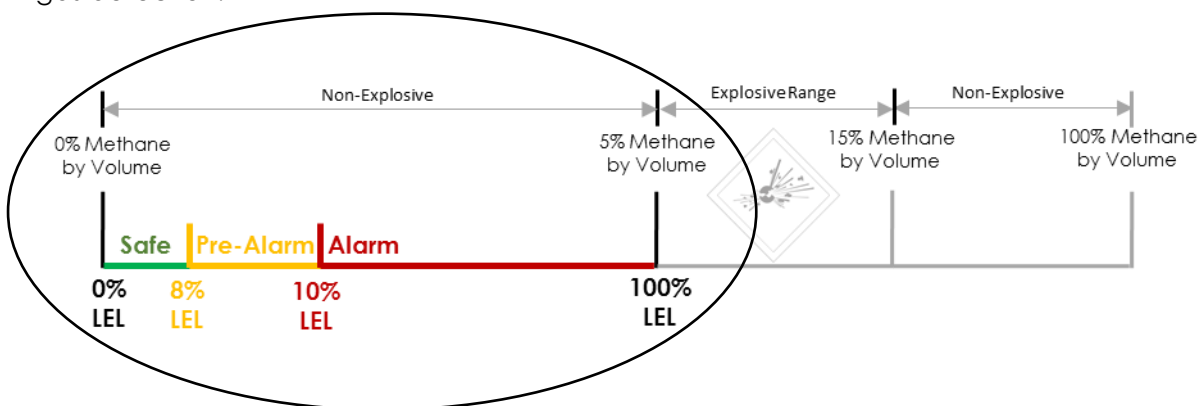

In simplified terms, a level of 8% LEL or less on your device is generally considered safe and acceptable.

For more information, please visit our website or contact your local AGS distributor.

INSTALLATION

Planning

Our monitors should be installed in areas at risk of gas leaks e.g. over boilers, valves or meters. Take in to account the design of the air flow patterns within the zone area.

Detectors should be installed in the correct orientation, as recommended by the manufacturer, and ease of access should be accounted for to allow for any bump tests and other forms of maintenance.

Typical Location and Positioning

Consider the coverage required and function of the area. Emphasis should be placed on airflow patterns and correct placement, not perceived detecting ranges. The target gas will only be identified when contact is made with the sensing element itself.

Multiple detectors may be required to adequately protect property and persons.

Locations for detectors will vary based on the intended application, they should be located near identified sources of a potential gas leaks / pockets where hazardous gas could quickly accumulate and areas of identified consequential risk.

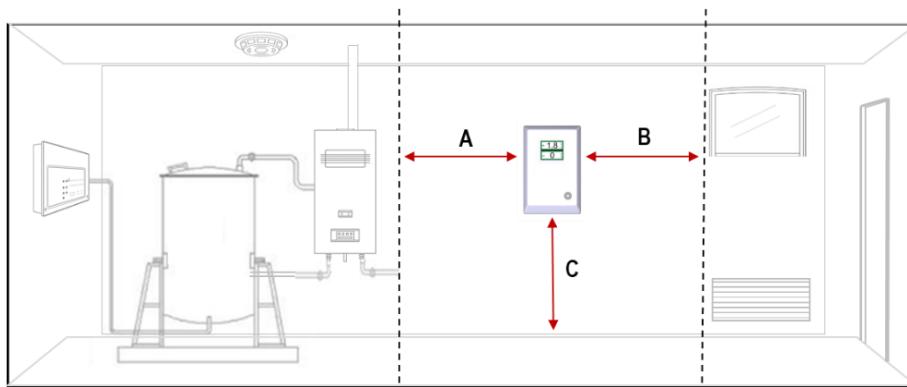

- A.** 6ft from sources of combustion e.g. boiler s/ heaters / gas fired appliances etc.
- B.** 4ft from draft zones and ventilation areas e.g. windows, doorways and A/C units etc.
- C.** 5ft from ground level.

Recommended heights may vary based on air flow and temperature conditions in addition to the proposed application and location. The device should be mounted near the boiler or gas fired appliances such as domestic & commercial boiler rooms and basements.

When choosing your location, make sure you are able to hear the alarm from all areas.

Avoid conditions of any other environmental factors that could potentially impede the accuracy and operation of the detector such as; condensation; vibration; temperature, pressure, the presence of other gases, electromagnetic interference and draft zones.

Mounting

Unpack all the parts!

1. Carefully remove the rear cover from the unit by releasing the two latching clips with a small flathead screwdriver.
2. Using the rear cover - mark the screw holes to the wall or align with the electrical box. If mounting direct to wall - ensure the wall surface is flat to prevent base distortion.
3. There are pre-fractured areas for cable entry and barrier to separate low and high volt connections.
4. Mount at 5 feet from ground level and in accordance with any applicable regulations.
5. After executing the mounting and connections – secure the rear cover.

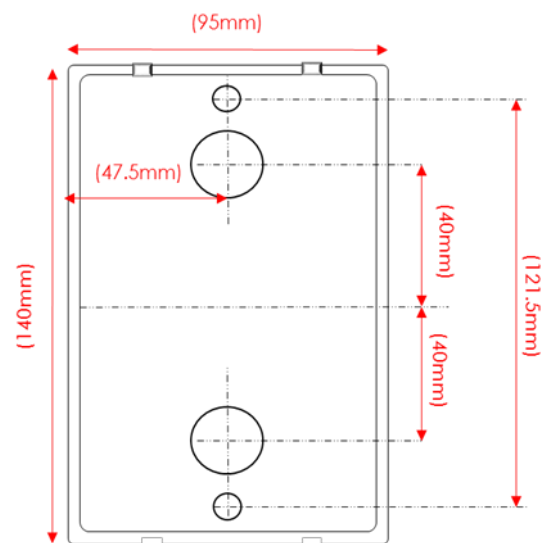
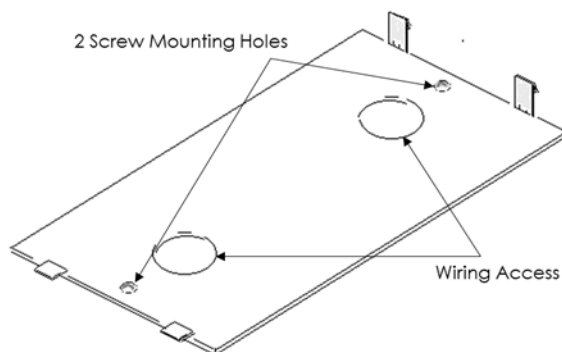
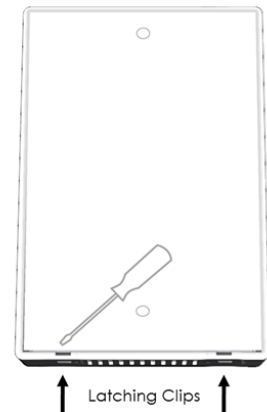

*Take care when making connections to high voltage connectors!
Any damage attempting to remove the circuit board may void any warranty!
Wiring of different circuits shall be separated by means of routing, clamping or barrier!*

Circuit Board Overview

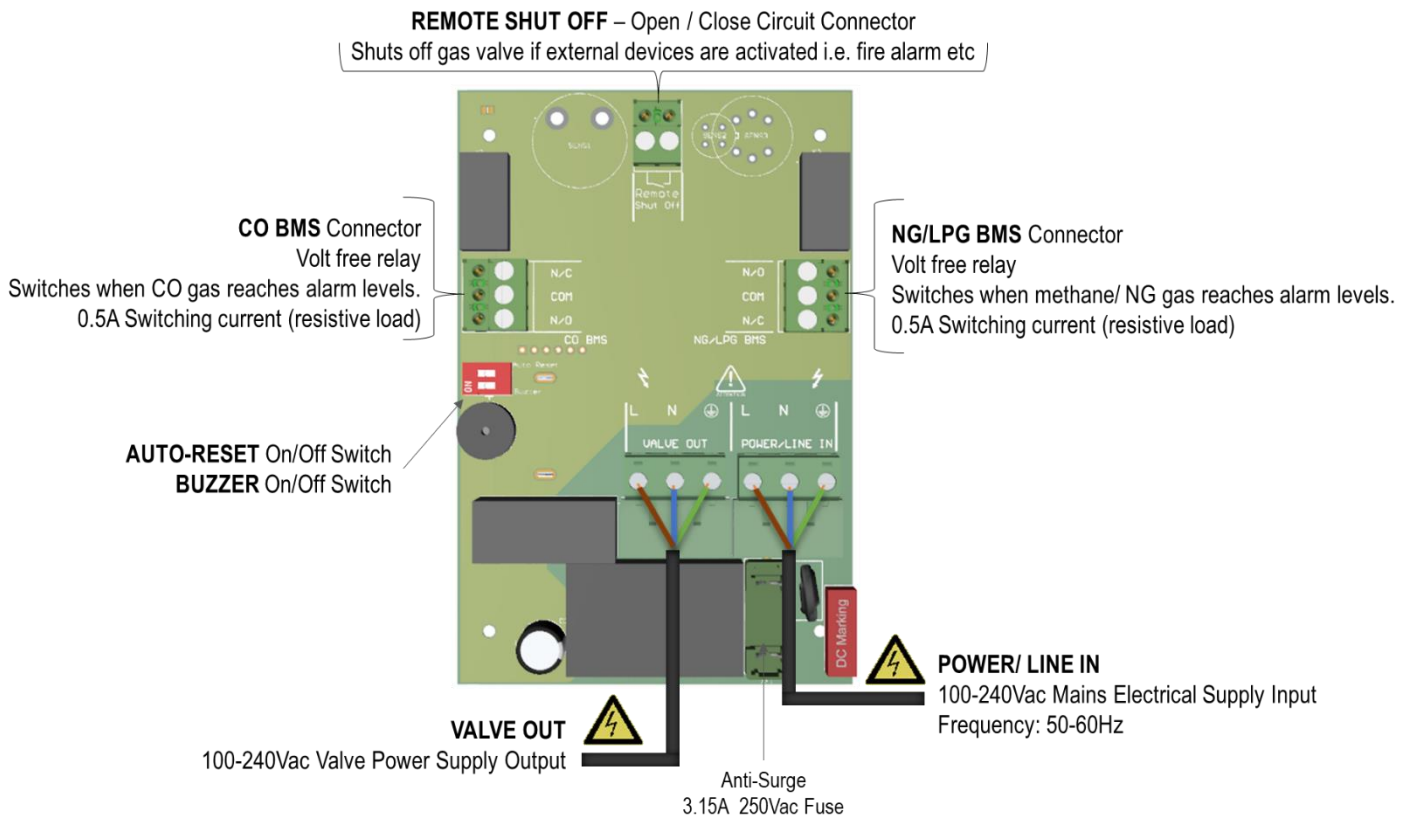

Wiring

Gas Valve Output

A gas solenoid valve should be powered using the terminals marked [VALVE OUT].
 When the valve out terminal is wired to a normally closed (NC) gas solenoid valve, the device can be used to isolate the gas supply for multiple appliances.
 Use an external transformer (not supplied) to close a 24VAC gas solenoid valve that could supply gas to one or more appliances.

Gas Supply Controlled by 100-240VAC Solenoid Valve

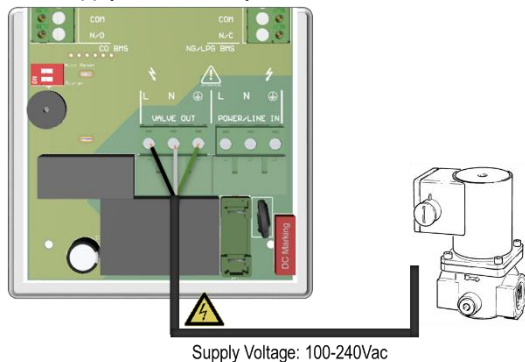

Gas Supply Controlled by 24VAC Solenoid Valve

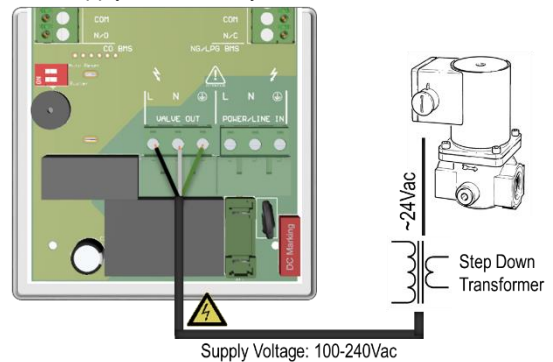

*We do not recommend installing a gas solenoid valve with standing pilots!
 If you use a gas solenoid valve, please note that standing pilots will need to be re-lit!*

Appliance Limit Circuit

The device can be used to directly shut down a gas appliance when a fault condition is detected (gas leak), by wiring the normally closed (NC) and common (COM) terminals of one BMS into the low voltage safety limit circuit of the appliance.

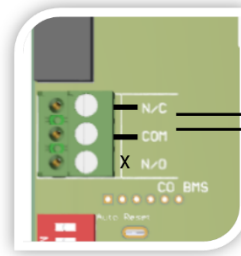

Typical boiler control board

HEAT THERMOSTAT
DHW TEMP SWITCH
DHW TEMP SWITCH
EXTERNAL LIMIT
OUTDOOR SENS
ALARM
D
R
C

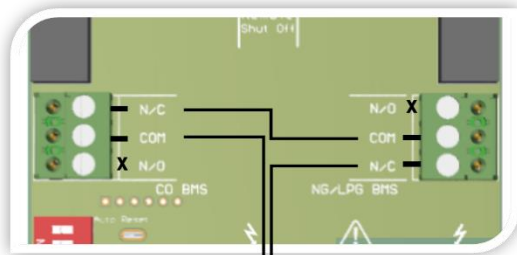

To connect both BMS terminals to the safety limit circuit of an appliance - wire in series as per the following diagram.

N/O not used.



If gas is detected, the circuit is opened, disabling the appliance. Multiple appliance limit switches can be wired in series.

Remote Shut-Off Connections

Your mini merlin can be integrated with remote devices with an open /close circuit via the Remote Shut-Off volt free switch terminal.

This terminal has a factory fitted link installed.

This terminal is normally closed and will alarm when energised open - isolating the gas supply.

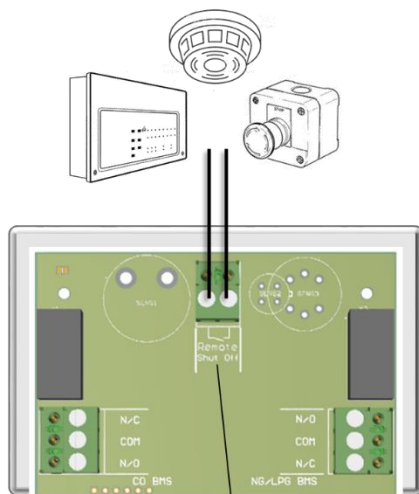

Factory fitted link.

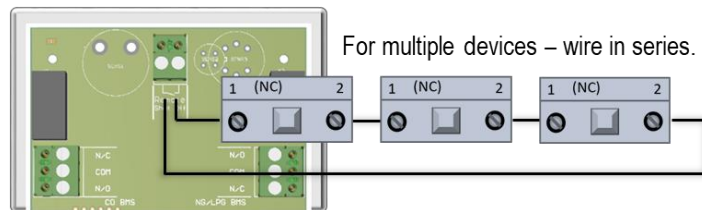

For multiple devices – wire in series.

When using this input, only the mains utility output shall de-energize. If you are using the CO or NG relay to shut down a boilers external limit circuit you will need to wire the remote panic in series with the relay output.

Auto Reset & Buzzer Switches

There are two dip-switches on the circuit board.



**Auto Reset
Buzzer**

	ON	OFF
Auto Reset	In the event of a power loss – the mini merlin will restart automatically when power is restored.	In the event of a power loss – the mini merlin will need to be reset manually when power is restored. This is the factory set condition.
Buzzer	The buzzer will sound every 15 seconds during pre-alarm and continuously at alarm level. This is the factory set condition.	The buzzer will not sound at any gas level.

Building Management System Integration

This device can be integrated with a Building Management System (BMS), a home alarm system, or be used as part of a boiler low voltage safety limit to make or break a circuit on both gases separately, (valve open or valve closed) depending on the system.

These switches can be used for a variety of purposes including triggering alarm contacts, operating and external relay for multiple appliance shut-down and generating status signals for a BMS system.

Specification

Product:	Mini Merlin
Version:	CH4CO
Display	1.8" TFT – Thin Film Transistor
Screen Brightness	Non- adjustable
Initial Stabilisation Time	60 Seconds approx.
Power Input Voltage	100-240Vac / 50-60Hz
Valve Output Voltage	100-240Vac / 50-60Hz
Fuse	Anti-Surge 3.15A 250Vac
Current Consumption	3W Max
Accuracy @ 25°C / 77°F	± <10%
Operating Temp	32 – 122°F 30-85%RH Non-Condensing
Audible Buzzer	65dB (controlled conditions @ 1 ft)
Volt Free BMS relay output	0.5A switching current (resistive load)
Gas Sensor Type	Methane: Semi-conducting Carbon Monoxide: Electromechanical
Gas Sensor Measuring Range	Methane: 500-10,000ppm Carbon Monoxide: 0-1000ppm
Gas Value Pre-Alarm	Methane: >8% LEL Carbon Monoxide: 20ppm
Gas Value Alarm	Methane: >10% LEL Carbon Monoxide: 20ppm after two (2) hours 50ppm after one (1) hour 100ppm after ten (10) minutes 300ppm after one (1) minute
Dimensions (mm)	95(W) x 140(H) x 60(D)
Weight	242g approx.

OPERATION

First Power Up



- Supply 100-240Vac electrical power
- Press and hold the touch button for ~3 seconds.

The device enters a stabilisation phase for approximately one minute – during this period the device is not yet ready for gas detection.

Touch Button

Turn device on.

Press and hold for ~3 seconds when electrical supply is connected.

Please Note: If your device has been configured to automatically reset – your device will power up automatically when electrical power is supplied.

Reset the device.

To reset after an alarm - press the touch button once.

Test device outputs.

Press and hold for 3 seconds during normal operation to test screen colouration, audible buzzer alarm and gas / BMS relay. This test only proves that the device will operate and activate connections as intended in the event of dangerous levels of gas being detected.

Device Overview

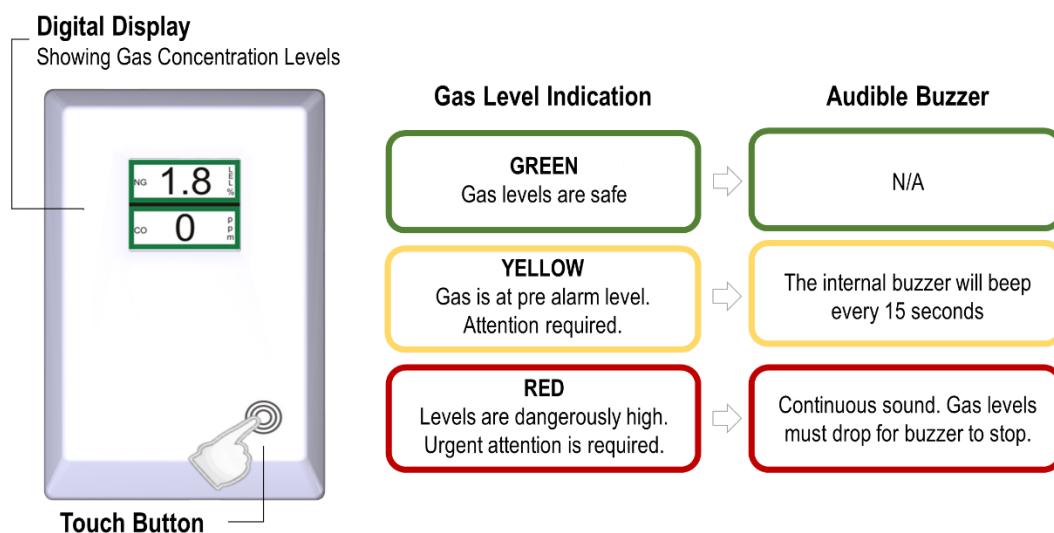

The user can choose whether to have the audible buzzer sound when gas levels are detected. For more information see section 'Auto Reset & Buzzer Switches'.

Gas Level Alarms

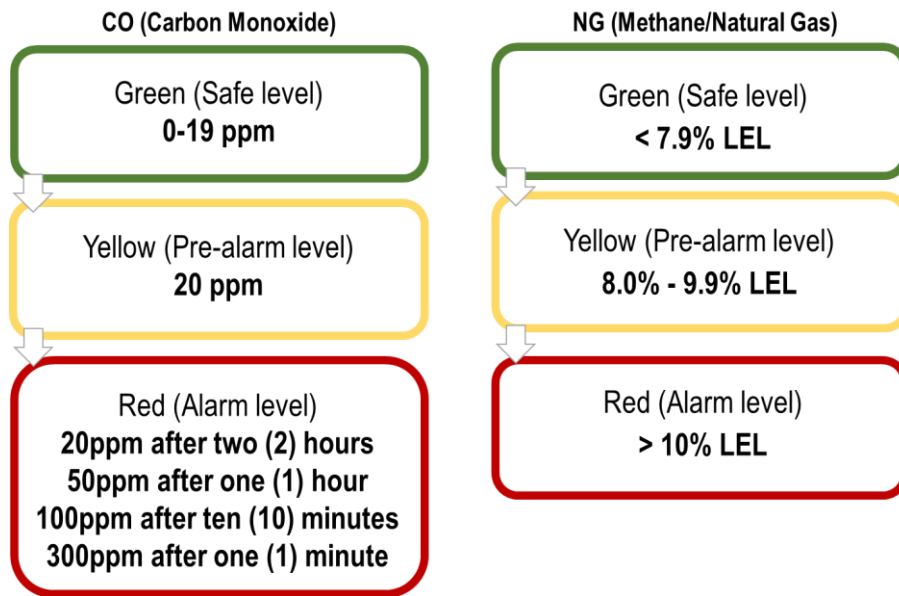

When alarms reach a RED status the maximum concentration level detected will be saved and the screen value will switch between the maximum (MAX) and the real time current value.

Remote Shut Off Screen

This message will display if the device is integrated with remote shut off devices such as smoke / fire alarms.

When activated, the device will isolate the gas supply if configured to do so.

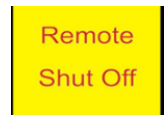

End of Life Screen

This message indicates that the devices gas sensing elements have reached their expected operational lifecycle. No gas levels will be displayed.

Contact your supplier and replace the unit immediately.



The expected lifecycle may vary depending on the environmental conditions!

General Maintenance

Keep your device in good working order follow these basic principles;

- DO carefully remove any accumulated dust from the outer enclosure once a month by using a slightly damp cloth.
- NEVER use detergents or solvents to clean your device – this may permanently or temporarily damage the gas sensing elements.
- NEVER spray air fresheners, hair spray, paint or other aerosols near the device.
- NEVER paint the device. Paint will seal vents and interfere with the device.
-

High concentrations of alcohol found in many products may damage, deteriorate or affect the gas sensing elements – such as; wine; deodorants; stain removers; thinners etc.

Other gases and substances to avoid; Corrosives (i.e. chlorine & hydrogen chloride); Alkali metals; Basic or acidic compounds; Silicones; Tetraethyl lead; Halogens and halogenated compounds.

Bump Testing

What is Bump Testing?

Bump testing is a term used for checking a gas detector is functioning correctly by exposing it to the target gas. A known concentration of the target gas is applied to the device to trigger an alarm condition and ascertain the detector is working safely.

Why is it Important?

A detector may visually appear in good order, but its sensitivity can be inhibited by external factors such as, dust; humidity; temperature fluctuations; cleaning products; contaminants or sensor drift (ageing). All can cause a decline in sensitivity and eventual failure.

The aim of the bump test is to make sure a gas detector is working at its optimum by briefly exposing the unit to a known concentration of the target gas. The reading (if displayed) is compared to the actual content of gas present, as stated on the test gas cylinder and if the detector goes into alarm within an acceptable range of the actual concentration, usually within 10%, then it is working safely.

If the bump test results are not within the acceptable range, the gas detector must not be used until a full calibration has been conducted.

Bump testing has a number of benefits for the end user:

- Peace of mind that the system does actually detect the gas in question.
- Allows the site to practice safe operations in a similar manner to the fire system.
- Early indication of any issues.

How Often?

Regular bump tests are important to make sure the detector is able to detect a release of gas as early as possible. A bump test usually takes seconds (gas type dependant) and is often completed alongside a scheduled fire alarm test, however the frequency should be determined following a risk assessment by the end user.

Current standards recommend that for new installations - it may be prudent to carry out a bump test frequently, following a successful initial period and as confidence grows in the installation concerned, the frequency could be reduced.

Remember, bump testing does not remove the need to have gas detectors inspected, calibrated and serviced periodically by a trained engineer. You should not attempt this yourself and should employ the services of a specialist company.

For more information on this, contact us.

Notes

INSTALLATION DETAILS

Please pass this manual to the system owner / user.

Date of Installation:	
Installation Location:	
Organisation:	
Stamp / Signature of the installer:	

S&S Northern Head Office

Tel: +44(0) 1257 470 983
Fax: +44(0) 1257 471 937
www.snsnorthern.com
info@snsnorthern.com

South East Division

Tel: +44(0) 1702 291 725
Fax: +44(0) 1702 299 148
south@snsnorthern.com



S&S Northern is the owner of this document and reserves all rights of modification without prior notice.